



NOVELTY
in the range!

FRAMEX 80

WINDOW AND DOOR SYSTEM



Installation depth
80 mm



Quantity of chambers
7 chambers



Thickness of filling
up to 52 mm



Gasket system
3-seals



Coefficient of heat transfer resistance
1,1 W/m² K

CONTACT US

Tel.: 0 800 21-00-21
e-mail : info@framex.ua

SCAN HERE

for detailed
information



framex.ua

Main profiles

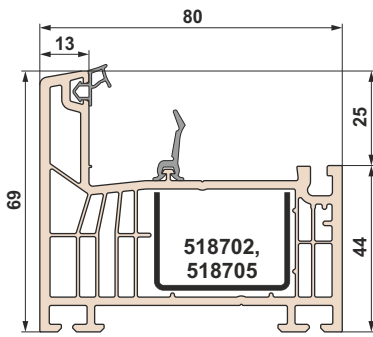

871010 Frame

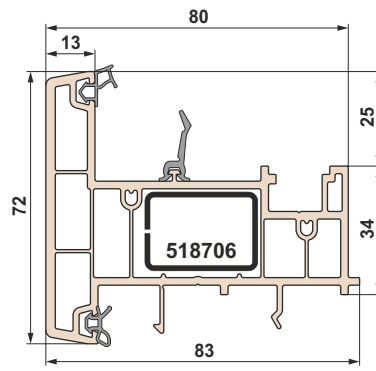

873020 Stulp

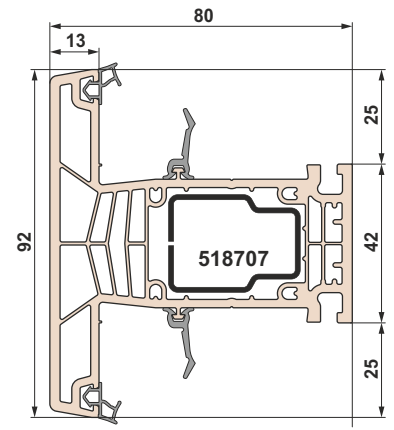

873010 Impost 80/92

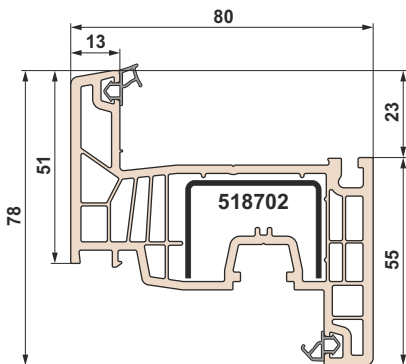

872010 Window sash

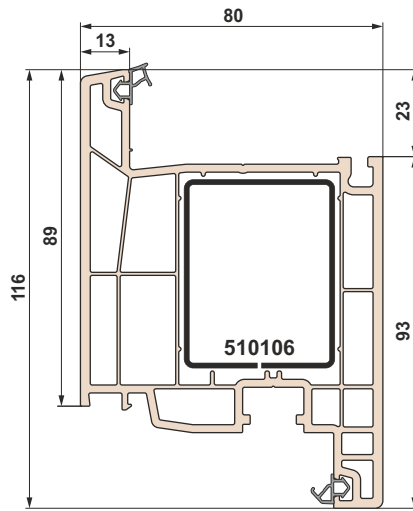

872040* Door sash of inside opening

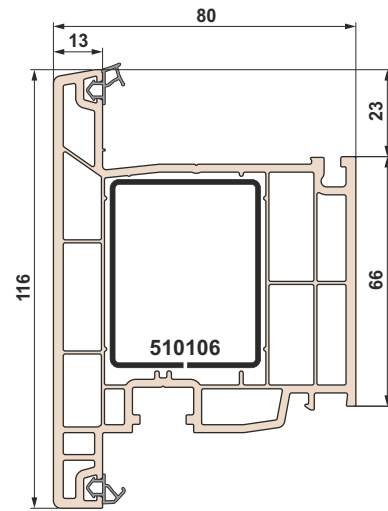

872020* Door sash of outside opening

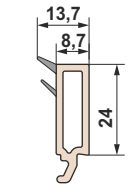

874652 Glass bead (glass unit 52 mm)

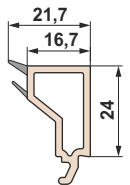

874644 Glass bead (glass unit 42 mm)

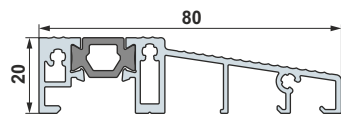

879750* Threshold with thermal insert

Accessories

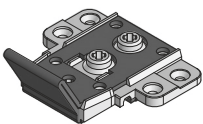

FR80 Impost connector

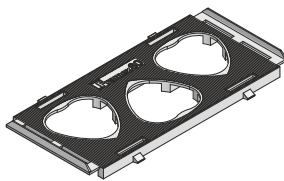

876510 Insert for glass unit

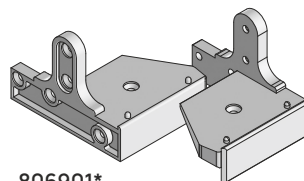

806901* Threshold adapter (set)

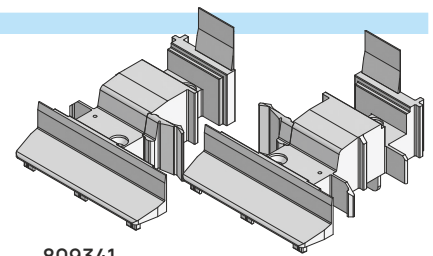

809341 End caps of shtulp (set)

Additional profiles

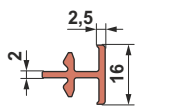

805001 **58 71 80** Balcony (window) connector

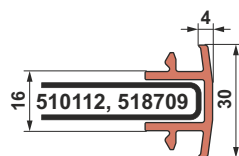

805002 **58 71 80** Weather bar connector

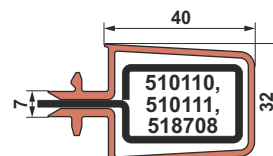

805003 **58 71 80** Pilaster connector

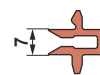

805004 **58 71 80** Connector 7 mm

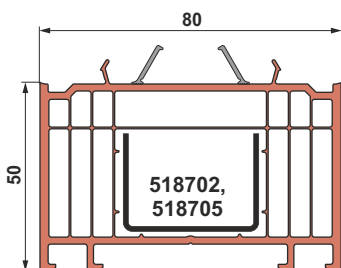

875050 **80** Expander 80/50

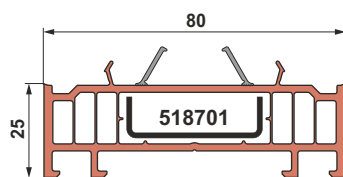

875025 **80** Expander 80/25

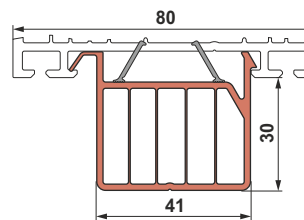

876030 **80** Rafter plate (Mauerlat) 80/30

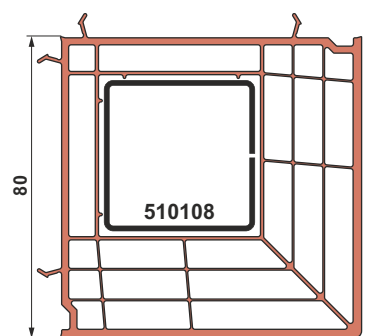

875120* **80** Corner connector 90°